













Thank you for purchasing a Harman Kardon AVR 635. This Quick-Start Guide will help you with a basic system installation. For detailed information on any step, please refer to the Owner's Manual pages referenced in this guide. We strongly recommend that you read the Owner's Manual for complete details on how to install, configure and operate the AVR 635, as well as for the important safety information it contains.

Figure 1 – Speaker Placement

The colors shown for each speaker correspond to the matching output terminal connection on the back of the AVR 635 (see page 8).

Connections Color Guide		
Audio Connections	Left	Right
Front		
Center		
Surround		
Subwoofer		
Surround Back		
Digital Audio Connections		
Coaxial		
Optical		
Video Connections		
Composite		
S-Video		

Match the colored jacks on the AVR 635 to the appropriate jacks on your source equipment or speakers. The colors are standardized, but not all equipment or connectors use them.

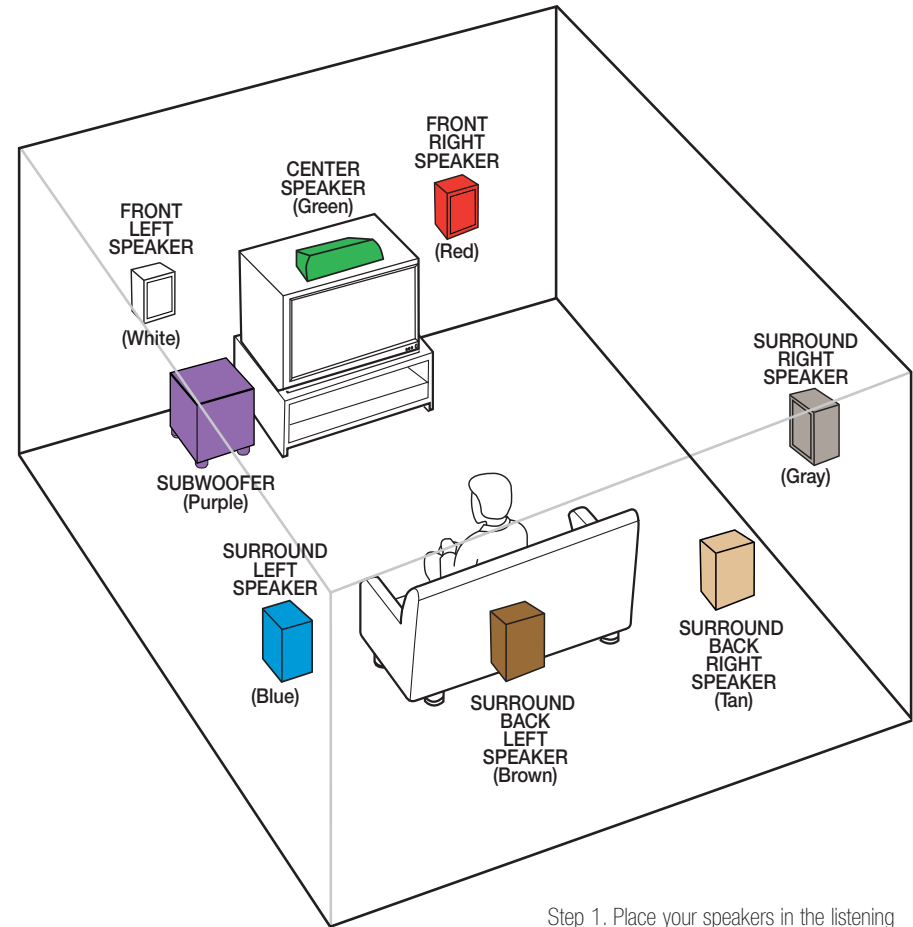

Step 1. Place your speakers in the listening room (see page 19).

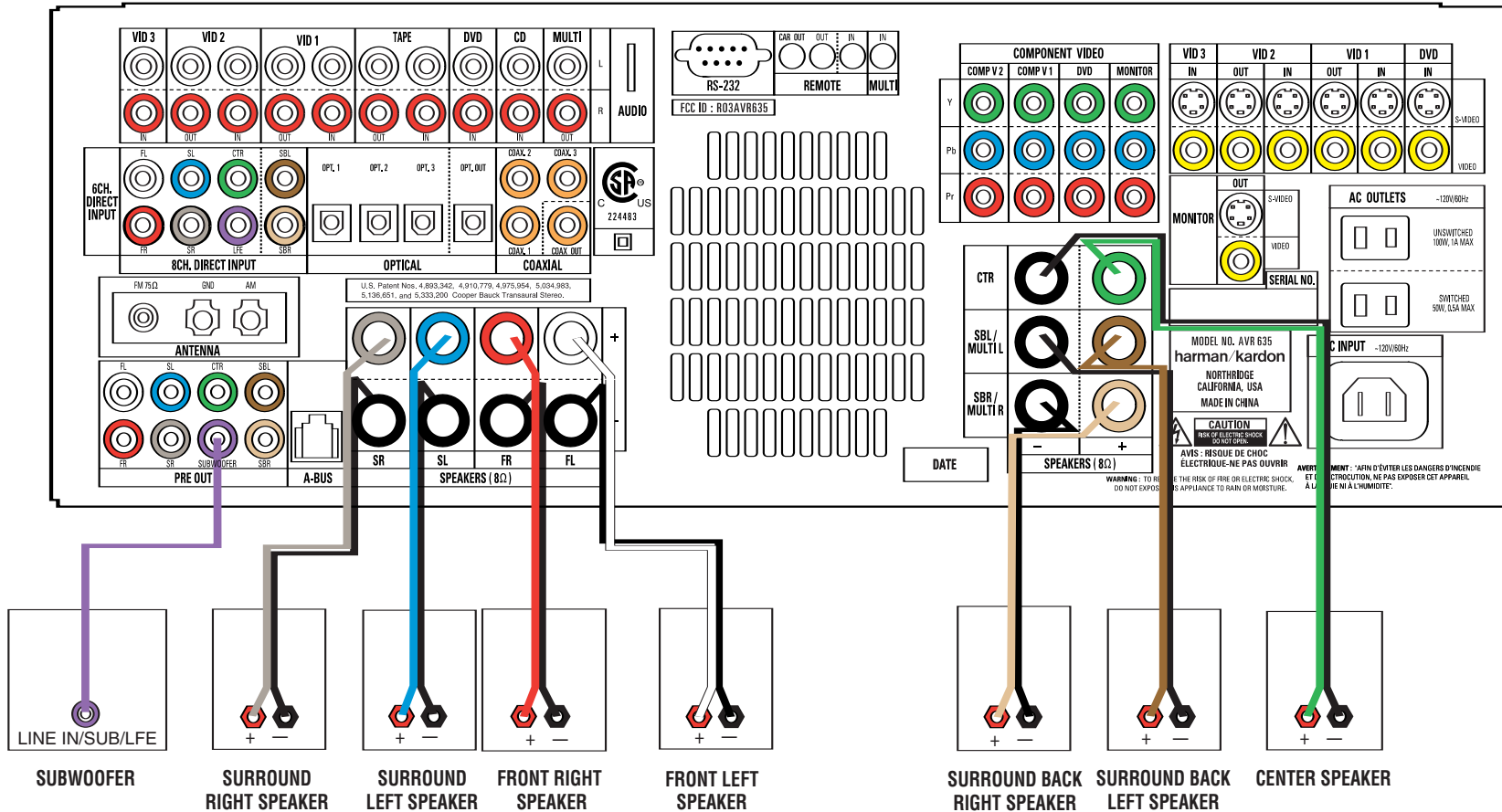

Figure 2 – Speaker Connections

- Step 2. Connect the speakers to the receiver: red (+) on speaker to colored (+) on receiver and black (-) to black (-) (see page 16).
- Step 3. Connect the Subwoofer Pre-Out jack to the Line-In jack on your subwoofer. You may adjust the settings on the subwoofer later as needed (see page 16).

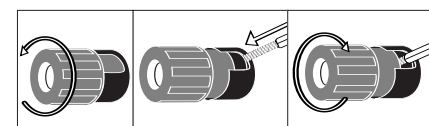

Figure 3 – How to Use the Binding-Post Speaker Terminal

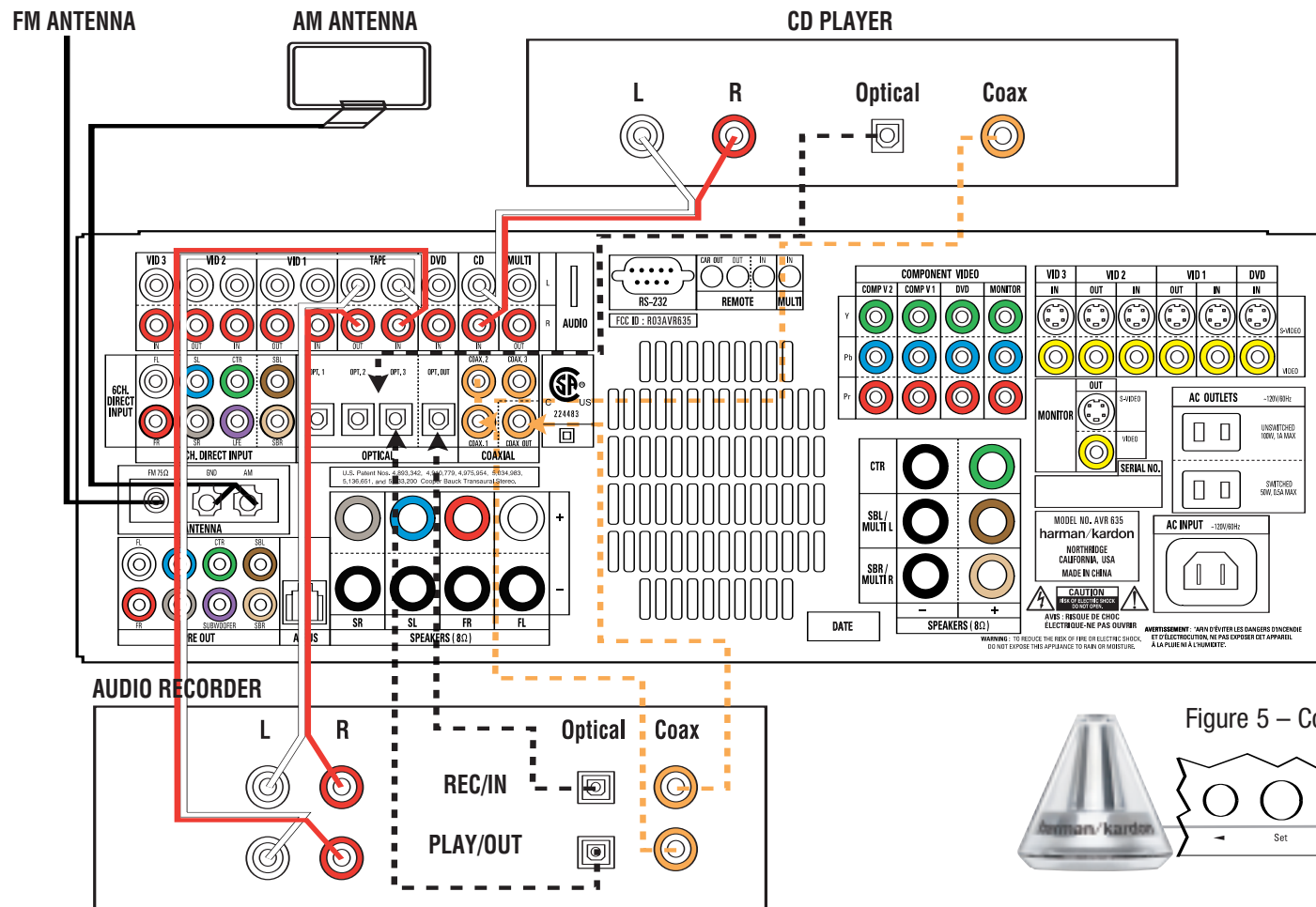

Figure 4 – Audio Connections
Dashed lines (---) indicate coaxial and optical digital audio connections. Choose either type (but not both) for each digital audio source.

Step 4. Connect AM and FM antennas (Fig. 4) (see page 16).

Step 5. Connect source components, as shown in Figures 4 and 5, and the Device Connection Options chart on the back of this guide (see pages 16–17).

AUDIO connections: Right channel (red) on source to right (red) on AVR, and left channel (white) on source to left (white) on AVR.

DIGITAL AUDIO connections, if available: Choose either coaxial (orange) to coaxial (orange) OR optical to optical for each device. The Coaxial 1 input defaults to the DVD player; however, it may be reassigned. Assign the other digital inputs and outputs as appropriate for your equipment (see Step 7).

VIDEO connections: Choose component (Y/Pb/Pr – green/blue/red), composite (yellow) or S-Video (4-pin) for each video source. The DVD Component Video inputs default to the DVD player, but may

be reassigned. Connect the component, composite and S-Video Monitor outputs to your Video Monitor (TV). Switch your TV set's input to match the type of video used for the currently selected source.

Step 6. Plug all components into AC power outlets. The outlets on the back of the AVR 635 should be used *only* for low-current products, such as CD or DVD players, and the total should not exceed 100 watts.

Basic Receiver Configuration

Step 7. **Select digital inputs:** If your DVD is connected to Coaxial 1, no adjustment is needed. For any other digital-device connections, use the front-panel Digital Select button and the arrow buttons to select an optical or coaxial digital input (see pages 21 and 35).

Step 8. Plug the EzSet/EQ microphone into the Microphone Jack behind the door on the front panel. Place the microphone at your preferred listening position and then follow the instructions on pages 24 to 26 of the

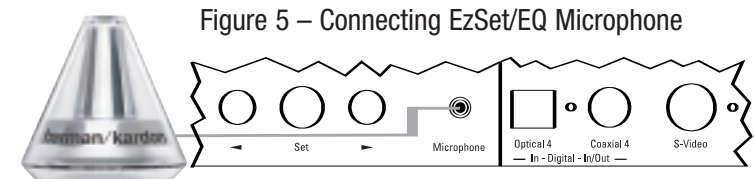

Figure 5 – Connecting EzSet/EQ Microphone

Owner's Manual and the on-screen menus to run EzSet/EQ. Note that you will hear a series of test tones and will then be instructed to move the microphone and point it toward the three front speakers during the second part of the calibration process. When the on-screen menu indicates that EzSet/EQ is complete, your system settings for speakers, delay times, channel output and room equalization are entered into the unit's memory. Unplug the microphone and keep it for future use.

Step 9. Your system is configured – sit back and enjoy.

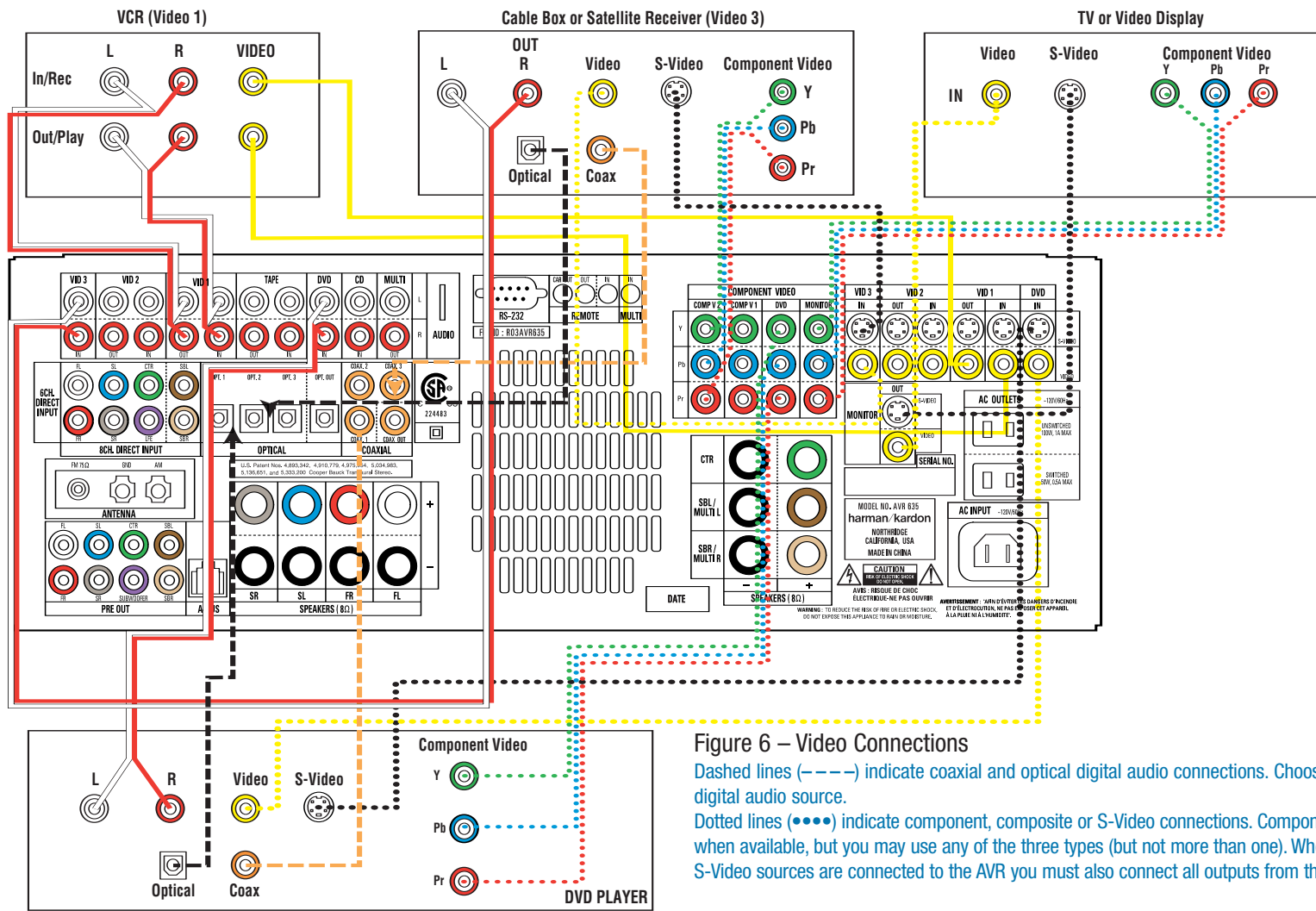

Figure 6 – Video Connections

Dashed lines (---) indicate coaxial and optical digital audio connections. Choose either type (but not both) for each digital audio source.
 Dotted lines (•••) indicate component, composite or S-Video connections. Component video is the preferred connection when available, but you may use any of the three types (but not more than one). When component, composite and S-Video sources are connected to the AVR you must also connect all outputs from the AVR to your TV.

Device	Input Name	Audio Input Connections	Audio Output Connections	Video Connections
CD Player	CD	CD L/R Inputs, Optical Digital 1, 2 or 3, or Coaxial Digital 1, 2 or 3	Not required	Not required
DVD Player	DVD	Coaxial Digital 1, 2 or 3, Optical Digital 1, 2 or 3, or DVD L/R Inputs	Not required	DVD Component Video Input, DVD Composite or S-Video
VCR	Video 1	Video 1 L/R Inputs	Video 1 L/R Outputs	Video 1 Composite or S-Video Input and Output
Cable Box or Satellite Receiver	Video 3	Video 3 L/R Inputs, Optical Digital 1, 2 or 3*, or Coaxial Digital 1, 2 or 3* Inputs	Not required	Component V2, Video 3 Composite or S-Video
Audio Recorder	Tape	Tape L/R Inputs, Optical Digital 1, 2 or 3, or Coaxial Digital 1, 2 or 3 Inputs	Tape L/R Outputs, Digital Optical** or Coaxial Outputs**	Not required
TV or Video Display	Not applicable	Not required	Not required	Monitor-Out Component, Composite and/or S-Video.

* Check with your cable company to determine whether digital audio is available for all channels. It may be necessary to make BOTH analog and digital connections if it is not. ** Digital audio recorders only.